

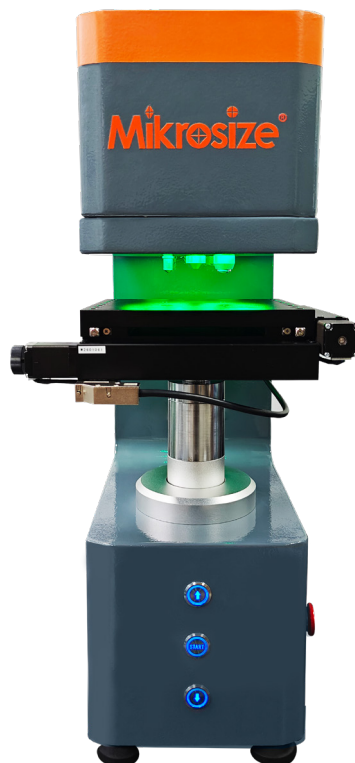

uVicky-50AI Intelligent Automatic Macro-Vickers Hardness Tester

Instruction Manual



Anhui Mikrosize Precision Instrument Co.,Ltd

Add: A-4035 RuiFeng Business Expo, Wuhu City, China, 241000.

Web: www.mikrosize.com **Email:** mikrosize@mikrosize.com

Contents

1. Installation and debugging of the instrument.....	1
2. About software installation	2
3.About software usage	4
4 About the "Camera" function in the software	7
5. About the "Settings" function in the software	7
6. About the "Data" function in the software.....	11
7. About the software "tool" function	11
8. About the software turret function, time and brightness adjustment function	13
9 About the use of panoramic camera function	13
10. About machine working parameters and indentation.....	15
11. About the software automatic measurement and manual measurement functions.....	16
12. About the software hardness type conversion function	18
13. About the "Auto Focus" function	18
14. About the electric and manual movement of the XY two-dimensional translation stage and the Z lifting axis	19
15. About the software data logging function	20
16. About the "Geometry Measurement" function.....	22
17. About the "Multi-point Measurement" function.....	23
18. About the method and calculation of carburized layer	31

1. Installation and commissioning of the instrument

1. Working conditions of hardness tester

- 1.1 In the range of room temperature 10~35 °C;
- 1.2 Install horizontally on a stable foundation;
- 1.3 In a vibration-free environment;
- 1.4 There is no corrosive medium around;
- 1.5 Indoor relative humidity shall not exceed 65% .

2. Unboxing and Installation

- 2.1 Remove the outer packaging box, lift and remove the box, and take out the accessory box.
- 2.2 Lift the bottom plate, unscrew the 4 M10 bolts under the bottom plate with a wrench , separate the hardness tester from the bottom plate, and take out the hardness tester.(pay attention to safety).
- 2.3 Place the hardness tester on a stable workbench and drill a hole at an appropriate position on the workbench. The specific size of the hole is (Figure 1).
- 2.4 Take out the adjustment screw (1) from the accessory box and screw it on the bottom of the main body (Figure 2) and adjust it to a horizontal level.
- 2.5 Turn the rotary wheel (2) to allow the screw (3) to smoothly pass through the hole on the workbench and work normally.

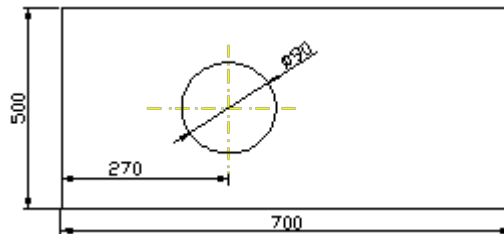

(Figure 1)

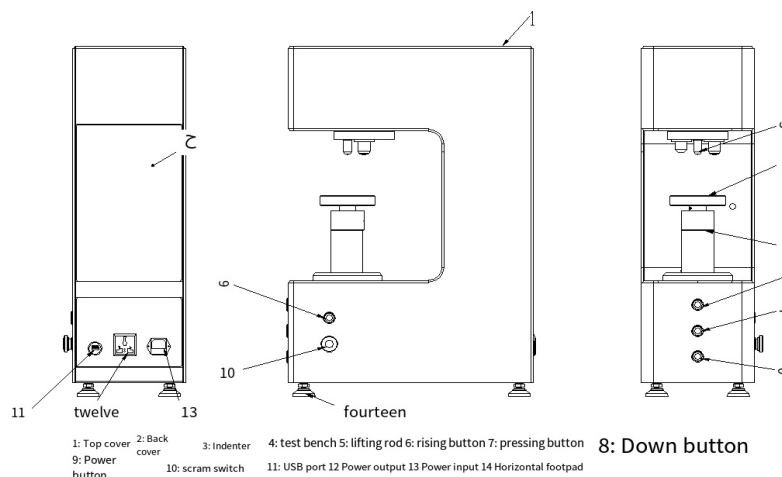

(Figure 2)

2.About Software Installation

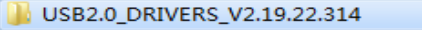
- 1.The software installation environment must be Win7/Win10 64-bit operating system; the computer CPU main frequency must be no less than 2GHz; the computer memory must be no less than 4GB.
- 2.Please close other security software and anti-virus software (such as 360 Security Guard and 360 Anti-Virus Software) before installing any software provided by our company.
- 3.Install the .net framework 4.8 operating environment (some computers already have this environment when the system is installed, so you don't need to install it).
- 4.Word report requires pre-installation of Office 2007 or above.
- 5.Install the camera driver - double-click  "Installer.exe " in the folder and click the "Execute" button, the software will be automatically installed.

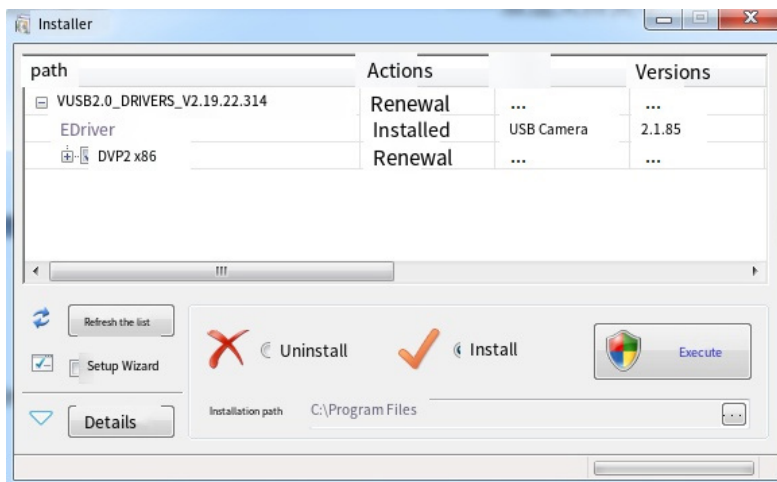

(For desktop computers, it is recommended to use the USB port on the back of the host to connect the camera)

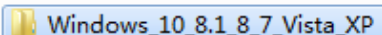
- 6.Double-click  the USB to serial communication cable driver in the installation directory  to install it. (Ignore in Bluetooth mode).

2.About Software Installation

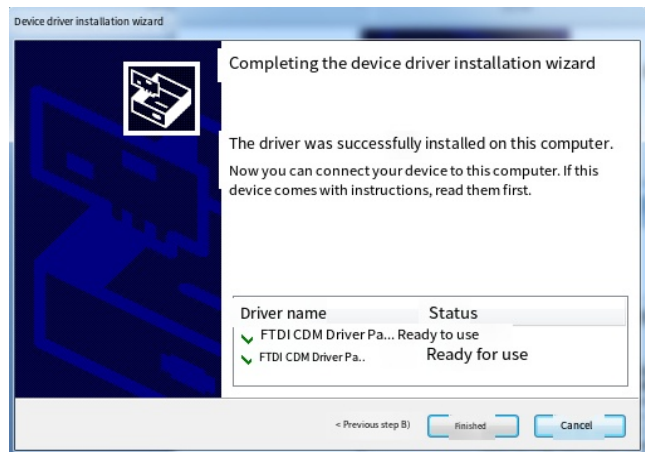
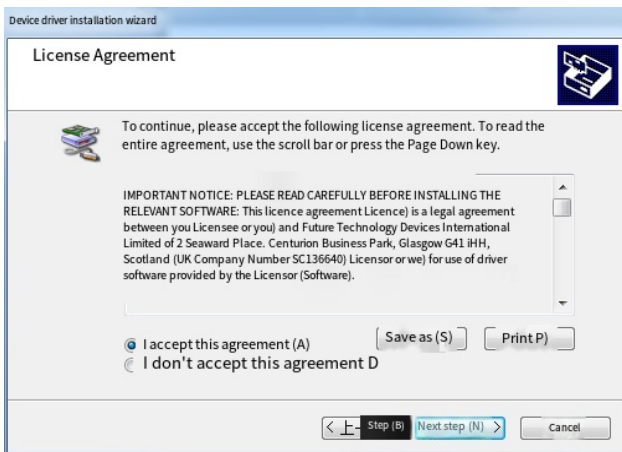
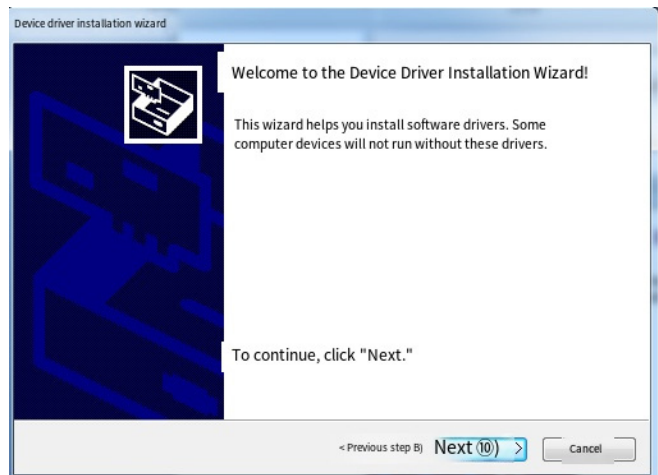
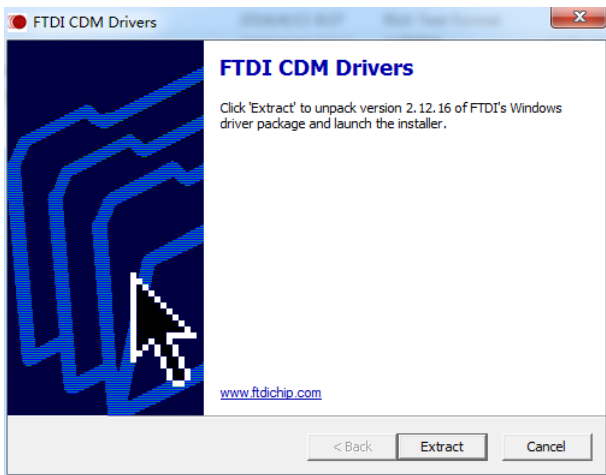

7. After copying the folder where the hardness tester software is located to the root directory of disk D, find the file  **AIO_Client.exe** in it and right-click it to send it to the desktop shortcut.

3.About Software Usage

1.Software operation steps

(1) You need to open the hardness tester first, wait for the hardware to start normally, and then open the hardness tester software.

(2) When you run the software for the first time, you may be prompted that the serial port initialization failed, as shown in the following figure.

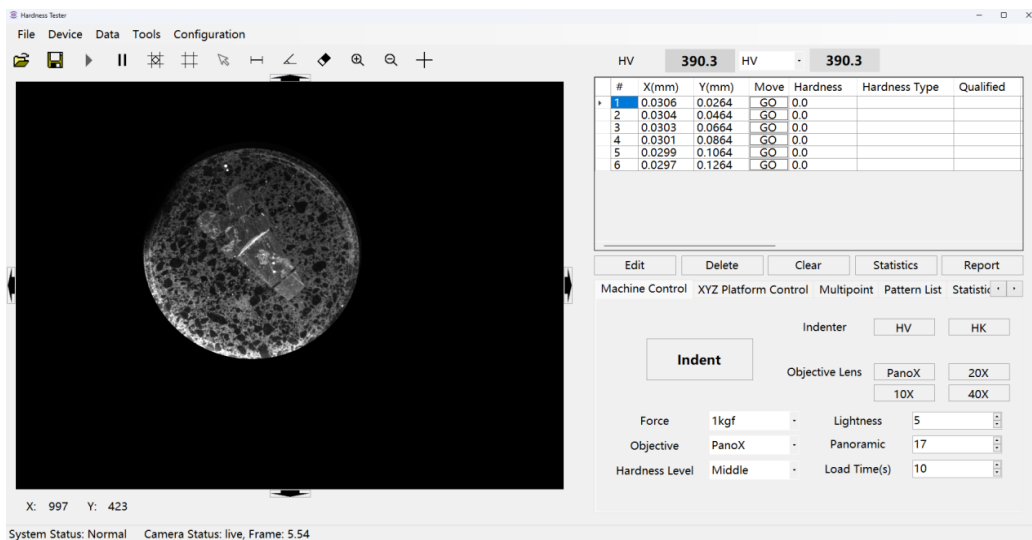

- Serial Port Settings " on the software interface , and in the pop-up interface, change the "Serial Port Number" to the serial port number corresponding to the hardness tester connection. Main represents the hardness tester serial port; X/Y represents the stage serial port; Z represents the serial port on the hardness tester responsible for controlling the vertical movement of the stage.

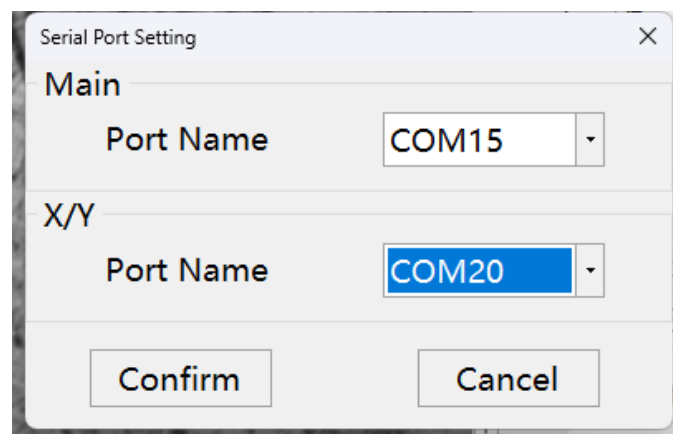

3.About Software Usage

(3)The overall software is as follows:

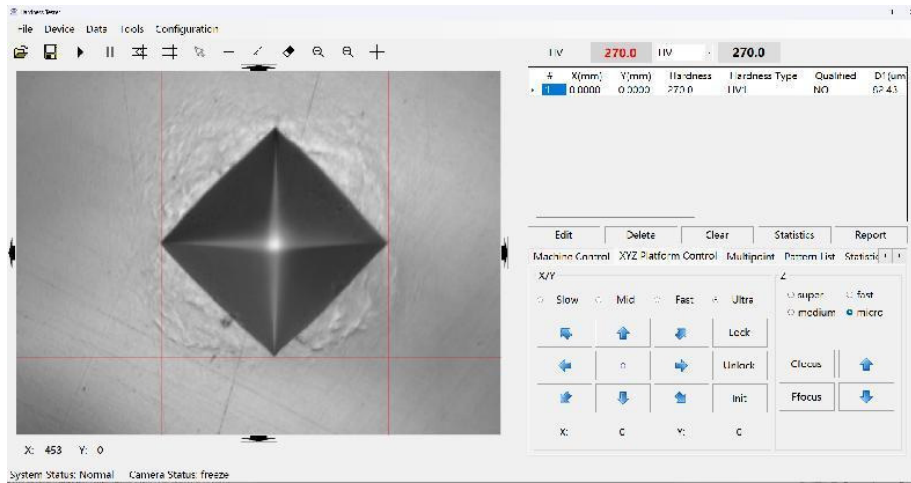

(1)Click the "Open Image" button under "File"

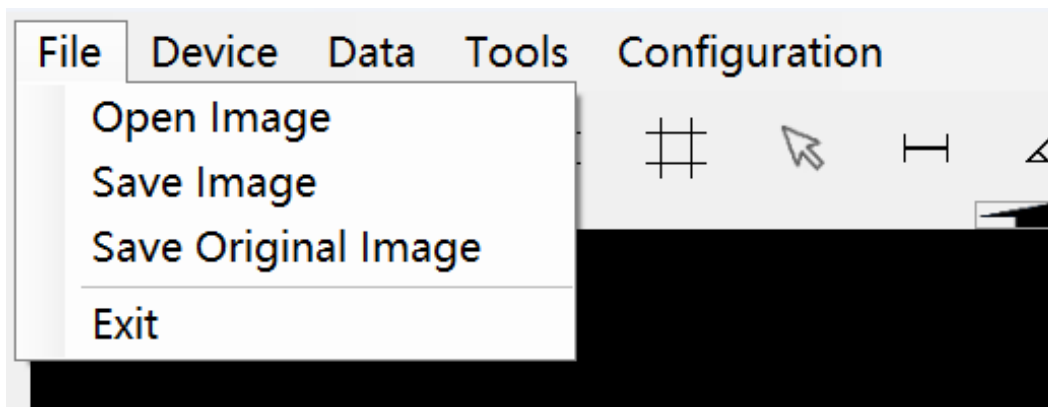

(2) In the pop-up dialog box, select the image you want to open (the supported image formats are).

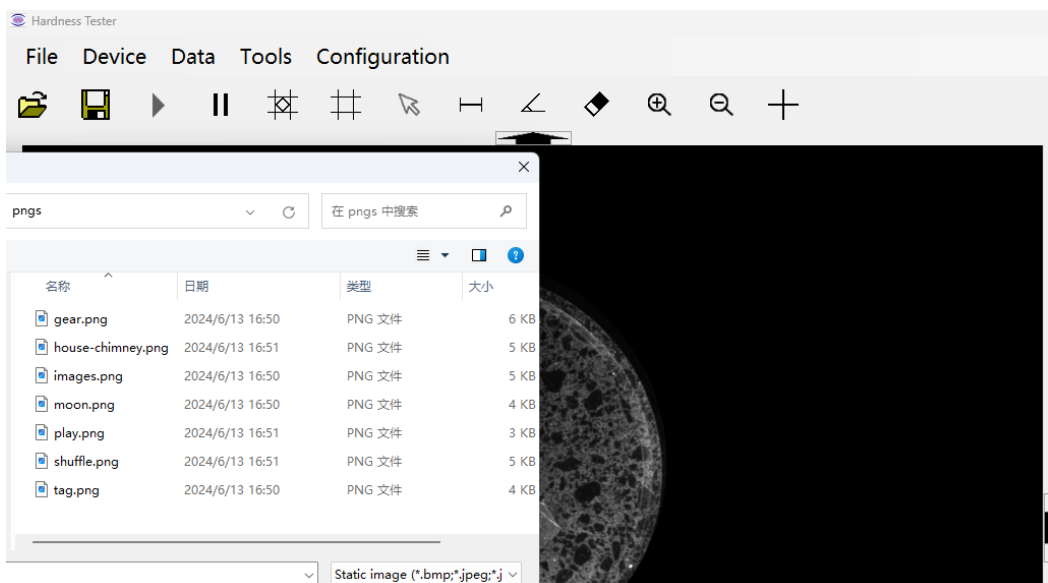

3.About Software Usage

(3) Click the "Open" button in the lower right corner and the image will be loaded into the software.

(4) When using the Open Picture function, the camera will be stopped. If you need to view the image captured by the camera again, you need to click  the button at the top of the software.





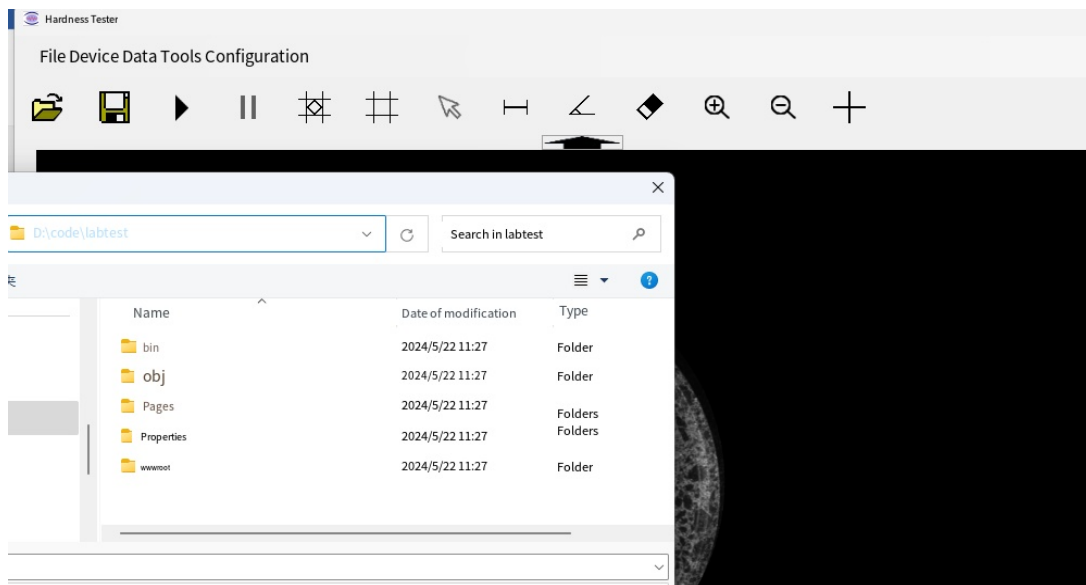

About the "Save Picture" function in the software

(1) Click the button



(2) In the pop-up save dialog box, select the save path, enter the save name, and click the Save button to save.



(3) The software saves images in the "OriginalImages" directory by default. Please clean up the images regularly to avoid excessive storage and affecting the software operation.

 Config	2021-05-06 16:47	Folder
 HardnessConvertTable	2021-05-06 16:47	Folder
 Logs	2021-05-06	folder
 OriginalImages	16:472021-05-06 16:47	folder
 Template	2021-05-06 16:47	Folder
 AIO_Client.exe	2021-05-06 16:48	Applications
 AIO_Client.pdb	2021-05-06 16:48	Program I

4.About The "Camera" Function In The Software

- 1.After the software is started, the camera automatically enters dynamic browsing.
- 2.When the user clicks  the button, the camera will enter the static state from the dynamic browsing state. At this time, the picture is still and the user can measure the current picture; when the user clicks  the button, the camera will enter the dynamic browsing state from the static state. At this time, the focal plane to be measured can be adjusted.

5.About The "Settings" Function In The Software

1.About the Camera Settings feature

- 1.The "Camera Settings" function is only used to set camera parameters (customers are advised to use the default factory settings, which will help the stability of automatic measurement).
- 2.Click the "Settings-Camera Settings" button at the top of the software to bring up the camera settings page for settings.

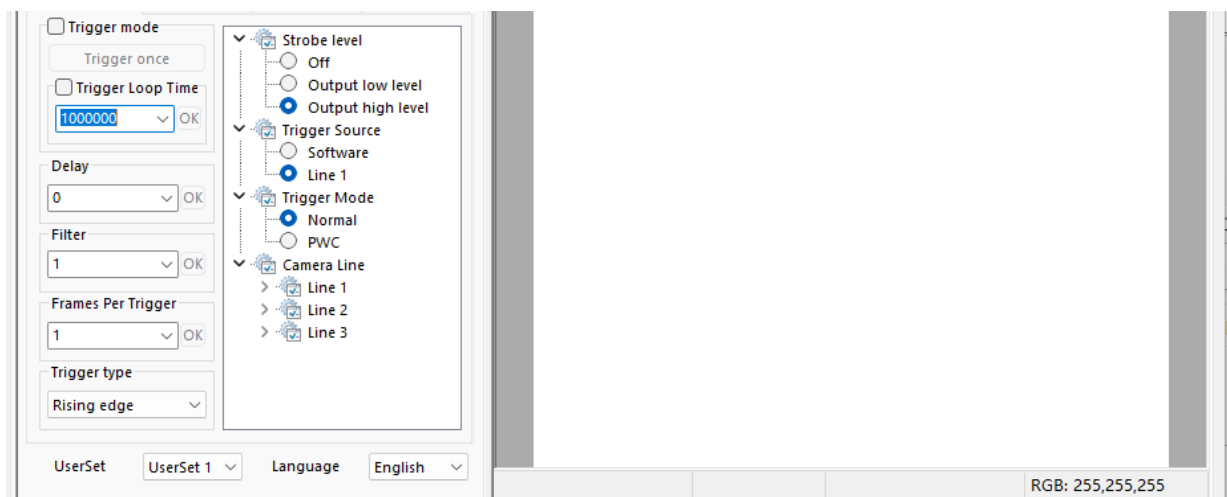

About the "Stage Setup" function

- 1.The setting function is used to set the XY platform motion parameters, Z axis focus parameters, and camera parameters(customers are advised to use the default factory settings or proceed under the guidance of the manufacturer's after-sales personnel).

5.About The "Settings" Function In The Software

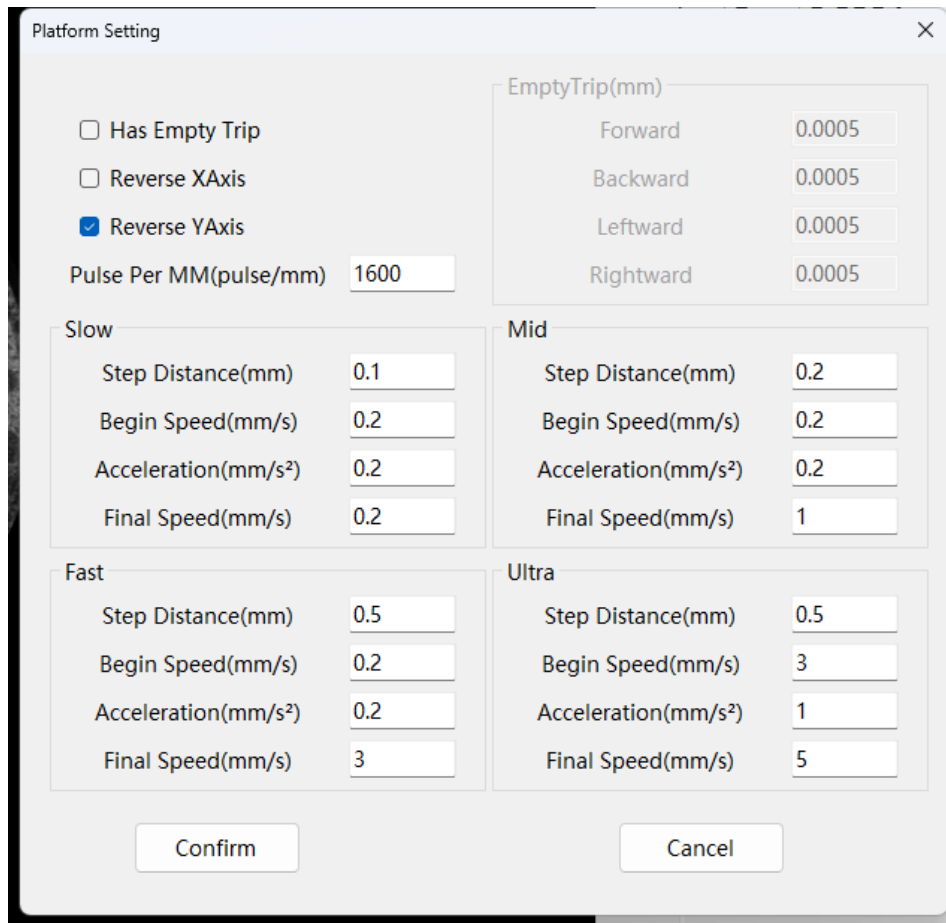

About the "Calibration Information" setting function

- 1.The software uses two calibration methods: hardness calibration and length calibration.
- 2.When precise measurements are required, we recommend that you calibrate with different hardness blocks.
- 3.First, use a hardness tester to make an indentation on a standard hardness block using the corresponding stress value.
- 4.The software then captures an image of the indentation.
- 5.Then click the "Settings-Calibration Information" button at the top of the software to bring up the calibration window.
- 6.Select "Hardness Calibration" in the calibration window.
- 7.Select the magnification of the current objective.
- 8.Select the force value to be used for the current indentation (note the unit).

5.About The "Settings" Function In The Software

9.Select the current hardness level.

10.Click the "Auto Measure" button and the software will automatically measure the pixel values of the current indentation in both horizontal and vertical directions.

11.Enter the hardness value of the current standard hardness block in the "Hardness Value" column.

12.Click the "Add Ruler" button and then click the "Close" button in the upper right corner to close the window.

13.The calibration steps for other different standard blocks are similar to the above.

#	X(mm)	Y(mm)	Move	Hardness	Hardness Type	Qualified
1	0.0035	0.0097	GO	467.6	HV1	YES
2	0.2683	-0.4144	GO	497.7	HV1	YES
3	0.5332	-0.8386	GO	324.1	HV1	YES
4	0.7980	-1.2627	GO	497.7	HV1	YES
5	1.0628	-1.6868	GO	318.2	HV1	YES
6	1.3276	-2.1109	GO	344.6	HV1	YES

Edit
Delete
Clear
Statistics
Report

Machine Control
XYZ Platform Control
Multipoint
Pattern List
Statistic

Indent

Indenter

Objective Lens

Force

Objective

Hardness Level

Lightness

Panoramic

Load Time(s)

14.When using the "length calibration" method, a ruler (minimum unit 0.01mm) is required

15.Place the ruler on the test platform and locate the ruler graduation area.

5.About The "Settings" Function In The Software

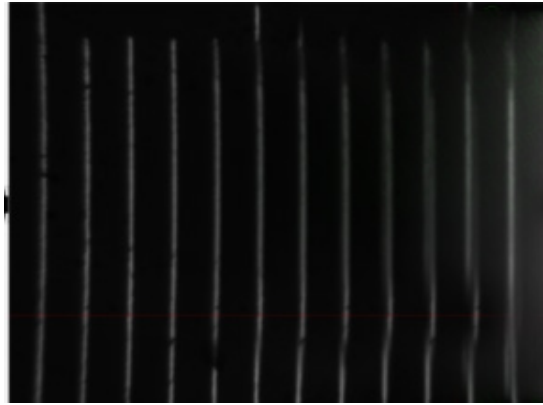

16.Click the two blue measurement lines in the image display area, and the calibration interface will automatically calculate the pixel distance between the two measurement lines.

17.Enter the actual distance in the "Physical Distance (μm)" column on the calibration interface .

18.Click the "Add Calibration" button and then click the Close button to complete the length calibration.

19.When performing hardness calibration, if clicking the "Automatic Measurement" button in the calibration interface fails to correctly measure the indentation, use the manual measurement method to calibrate (for the manual measurement method, refer to "About Manual Measurement").

20.When performing hardness calibration, if the indentation cannot be measured correctly by clicking the "Automatic Measurement" button in the calibration interface, you can also first select the "Settings -Automatic Measurement Settings" button to make adjustments, adjust the "Preprocessing" and "Indentation Selection" values, and click the "Save" button when the indentation is measured correctly.

6.About The "Data" Function In The Software

Sample Information" function

- 1.Sample information settings are mainly used for exporting measurement reports.
- 2.The user can set the following information of the current test sample:

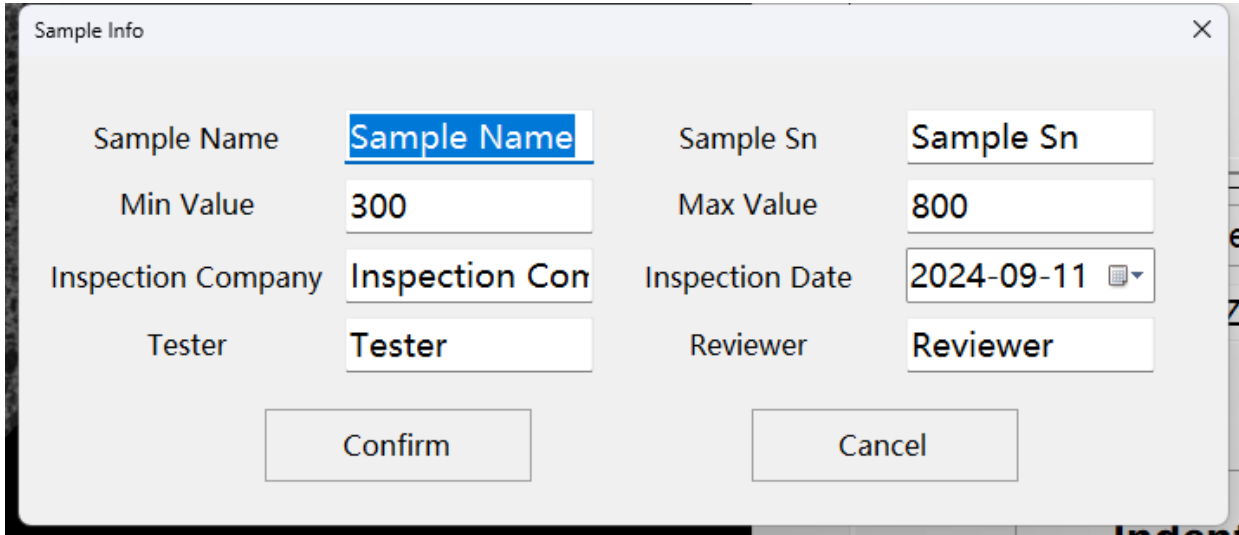

Sample Info

Sample Name	Sample Name	Sample Sn	Sample Sn
Min Value	300	Max Value	800
Inspection Company	Inspection Con	Inspection Date	2024-09-11
Tester	Tester	Reviewer	Reviewer

Confirm Cancel

7.About The "Tools" Function Of The Software

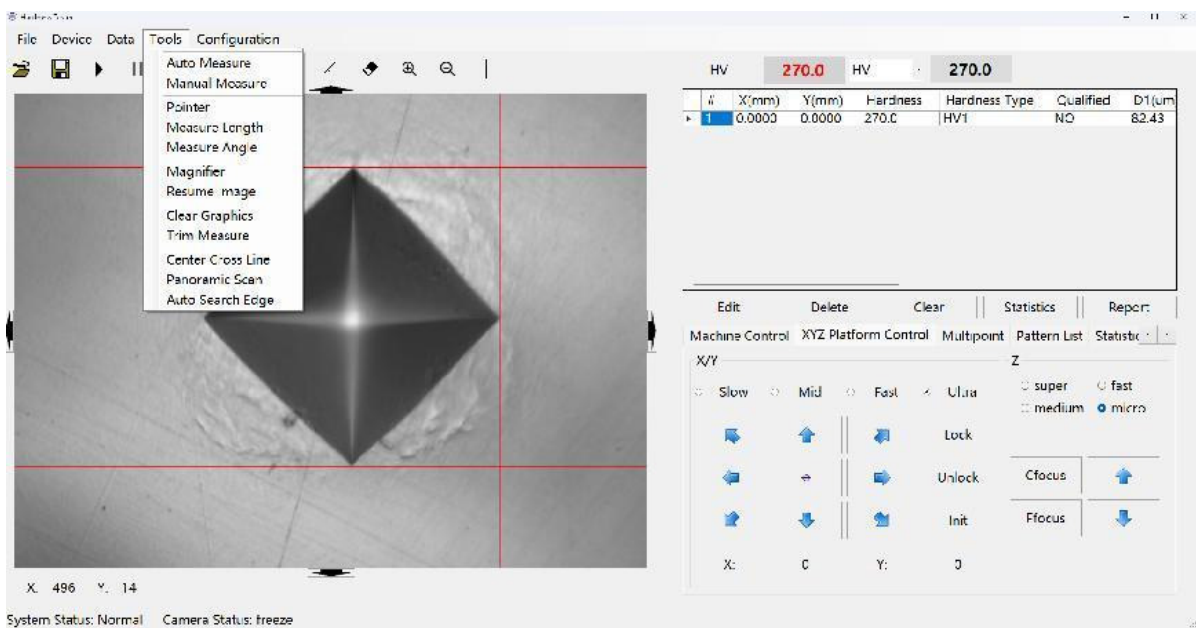

- 1.Automatic measurement: can automatically measure indentation
- 2.Manual measurement: Manual measurement of indentation



7.About The "Tools" Function Of The Software

3. Mouse Mode: Mouse programming cross center line
- 4.Length measurement: measure length
- 5.Angle measurement: measure angles
- 6.Zoom tool: zoom in on the selected area of the image
- 7.Restore the original image: restore the enlarged image
- 8.Clear graphics: Clear the drawn measurement line
- 9.Measurement fine-tuning: adjust the measurement line position and adjust the hardness value in real time
- 10.Center crosshair: Display center crosshair
- 11.Panoramic Scan: Used to scan a static image of a panoramic camera
- 12.Automatic edge search : used to find the edge track of the inlay material

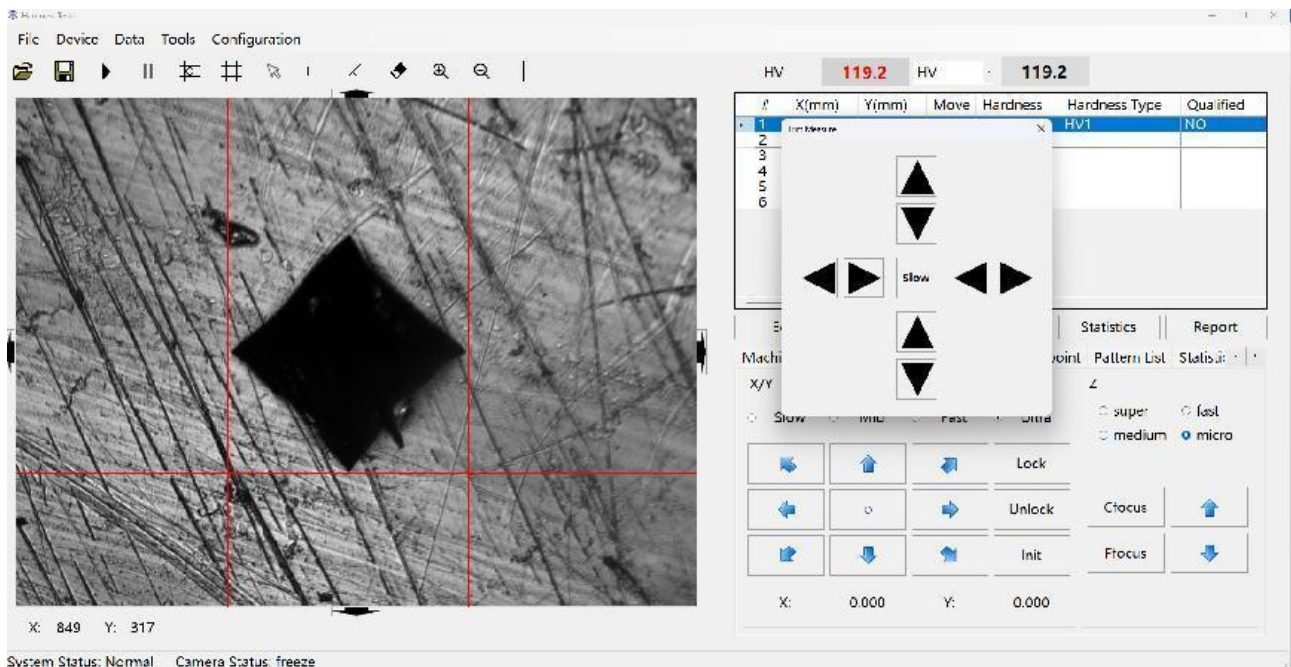
Fine-tuning test:

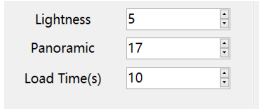

8.About The Software Turret Function, Time And Brightness Adjustment Function

- 1.Click  the button to turn the turret to the left objective.
- 2.Click  the button to turn the turret to the right objective.
- 3.Click  the button to go to the indenter.
- 4.Enter  the saturation time and the brightness of the light source.

9.About The Use Of Panoramic Camera Function

1. First, reset the XY stage to its original position.

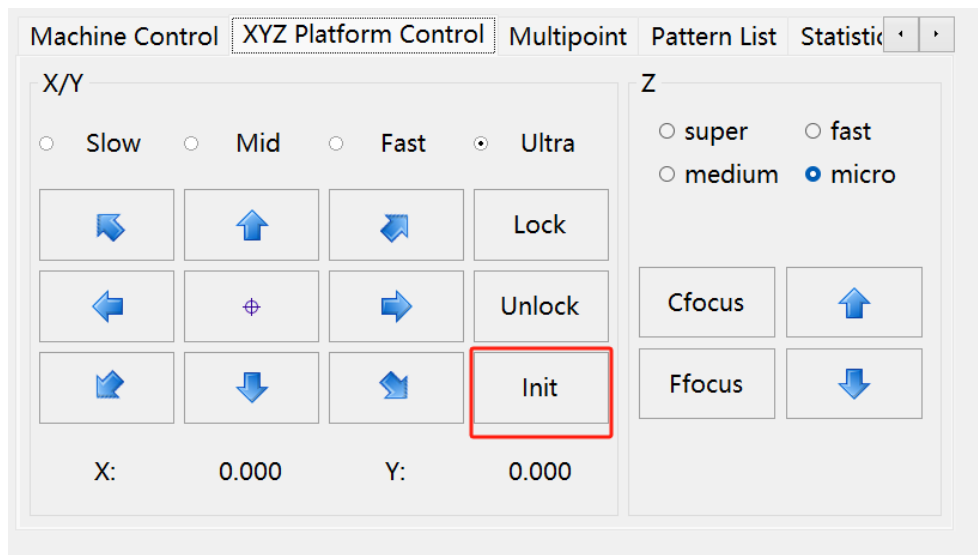

2. Go back to the panoramic camera and get a panoramic static image under Tools-Panoramic Scan.

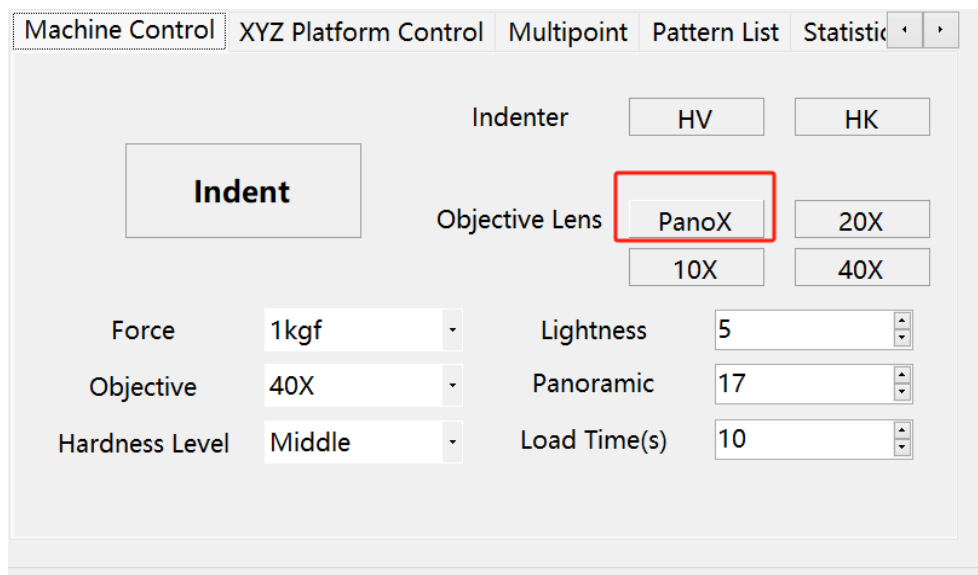

9.About The Use Of Panoramic Camera Function

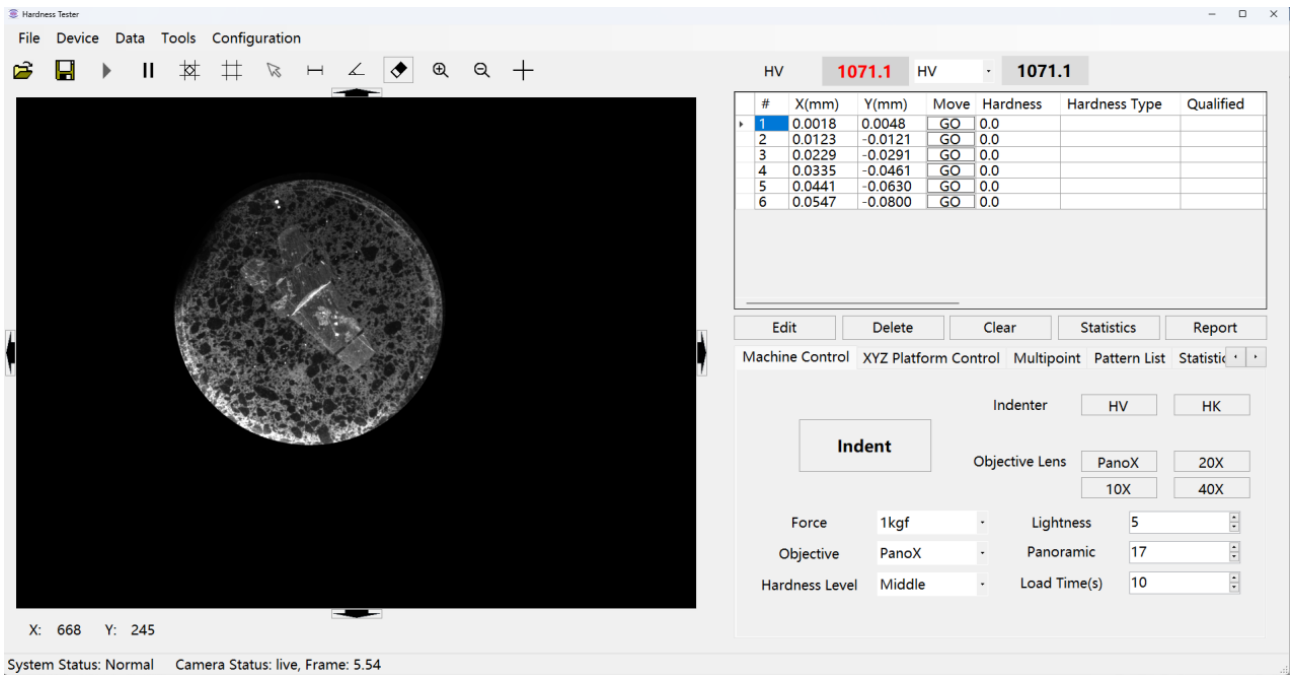

3. Return to the objective lens position And click " Panorama " to switch to macro mode

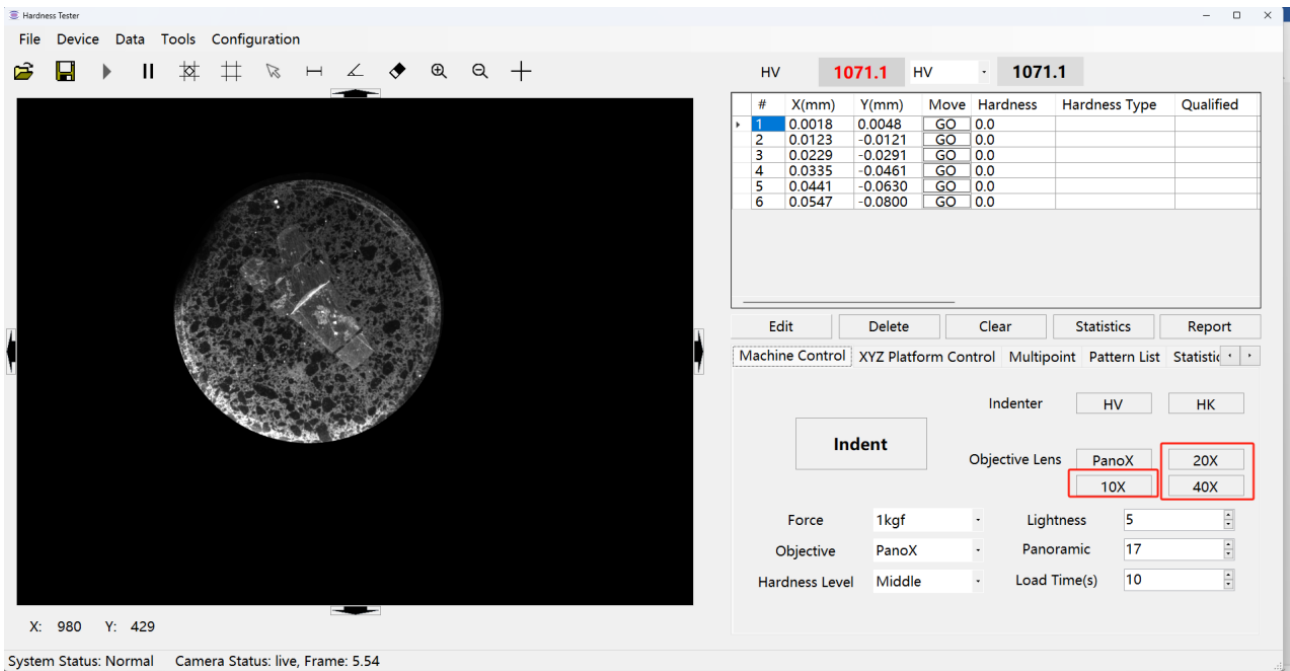



10.About Machine Working Parameters And Indentation

The screenshot displays the 'Machine Control' software interface. At the top, there are tabs for 'Machine Control', 'XYZ Platform Control', 'Multipoint', 'Pattern List', and 'Statistic'. The main area contains several controls:

- An 'Indent' button on the left.
- An 'Indenter' section with buttons for 'HV' and 'HK'.
- An 'Objective Lens' section with buttons for 'PanoX', '10X', '20X', and '40X'.
- Parameter settings for 'Force' (1kgf), 'Objective' (40X), 'Hardness Level' (Middle), 'Lightness' (5), 'Panoramic' (14), and 'Load Time(s)' (10).

- 1.Click the left and right buttons next to the "Turret" and the turret of the hardness tester will switch to the low-power and high-power objective lenses.
- 2.After selecting parameters such as force value, magnification, hardness grade, etc., the parameters on the hardness tester will be synchronized with the parameters here.
- 3.The pressing force value needs to be selected on the machine. The test force value in the software can only be used for hardness value calculation and cannot be transmitted to the machine.
- 4.Click  the button on the machine control page, and the hardness tester will automatically perform indentation and turret rotation after receiving the command.

11. About The Software Automatic Measurement And Manual Measurement Functions

1. Click the manual measurement button  in the toolbar  to measure.
2. After clicking the measurement button, if the camera is currently in "dynamic" mode, it will be converted to "static" mode, and the current image will be still.
3. After clicking the "Automatic Measurement" button, the software will automatically measure the collected indentation image and automatically draw four straight lines on the left, right, top and bottom in the image display area. The converted hardness value will be displayed on the right side of the "HV" word on the main interface.

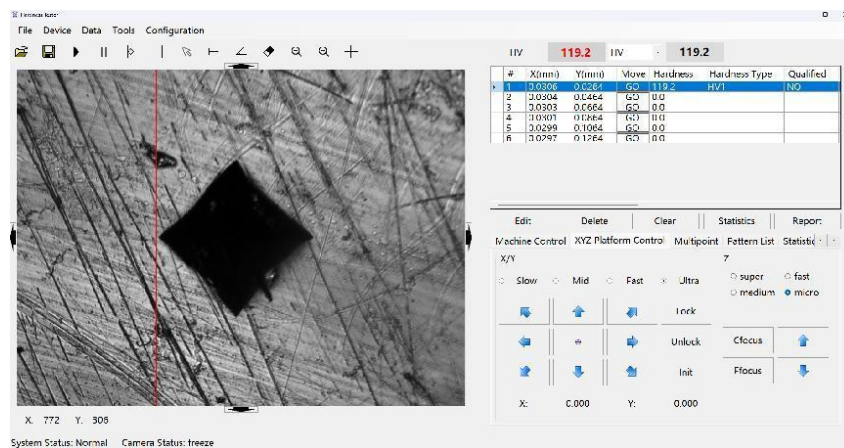

4. After clicking the "Measure Indentation" button, you need to click the left mouse button in turn to draw four straight lines (in the order: left, right, up, down) at the tangent points of the four vertices of the indentation to complete a measurement.

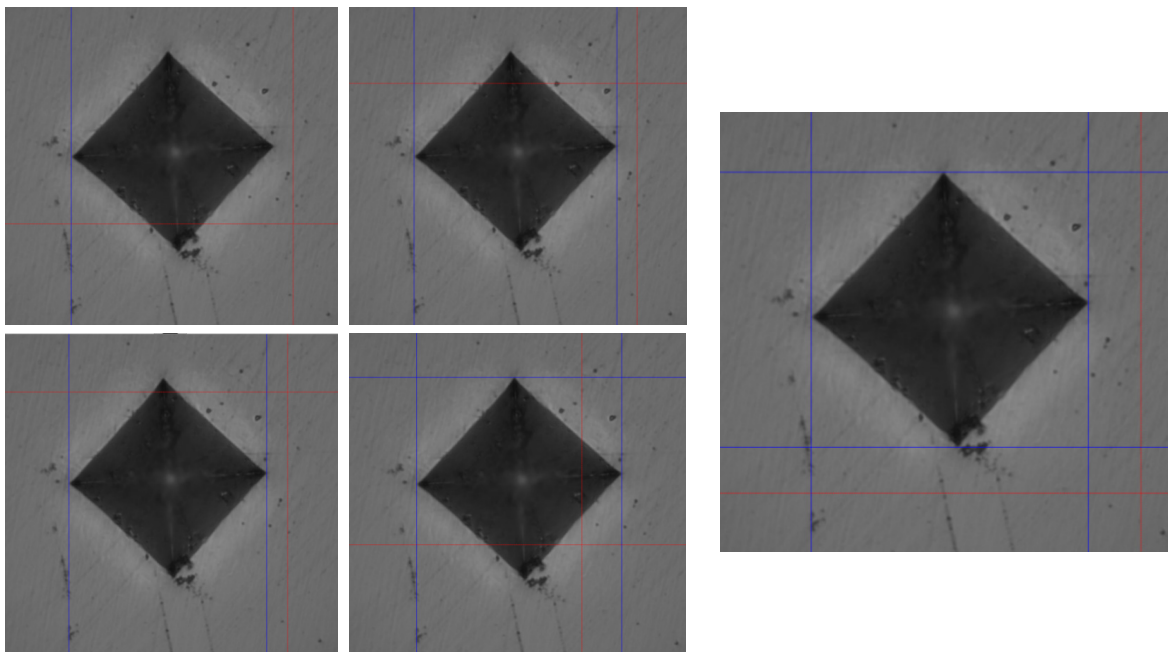

11. About The Software Automatic Measurement And Manual Measurement Functions

5. Whether it is manual measurement or automatic measurement, the test force value and magnification factor must be selected correctly, otherwise the calibration data called will be inaccurate and the measured hardness value will be wrong.

6. In the Measurement window, you can zoom in on a selected portion of the image by selecting the magnifying glass tool and dragging the box toward the lower right corner:

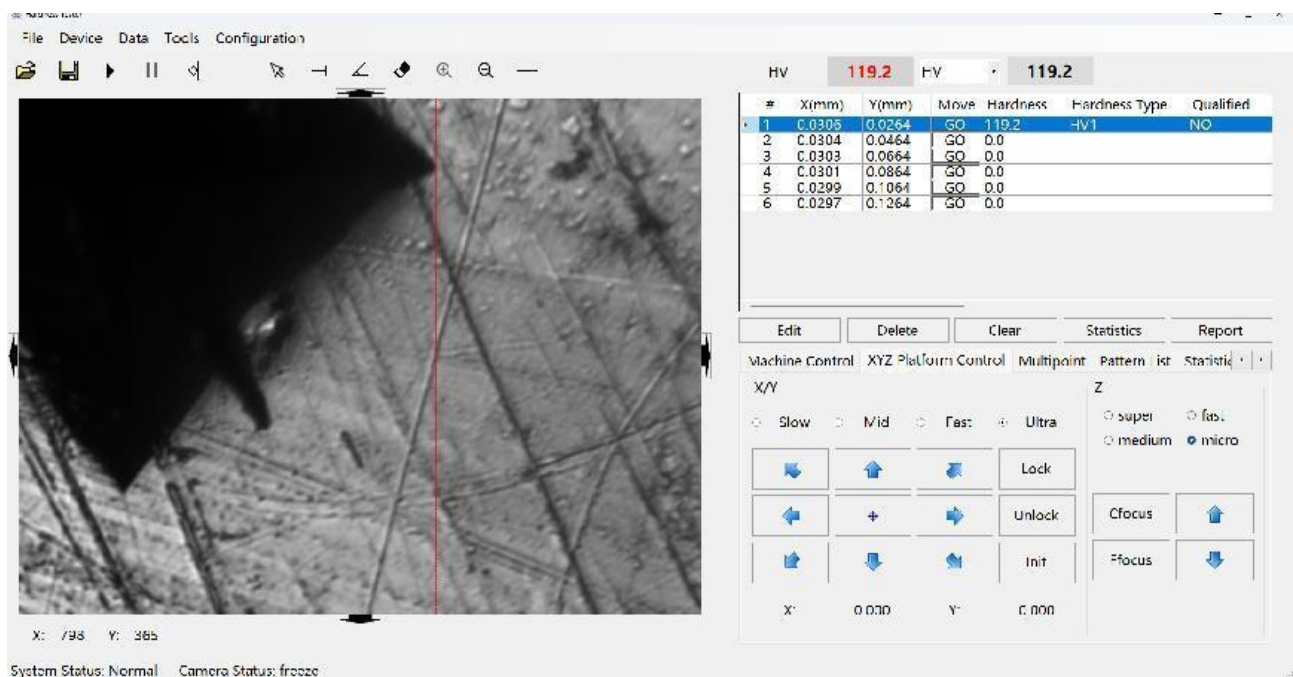
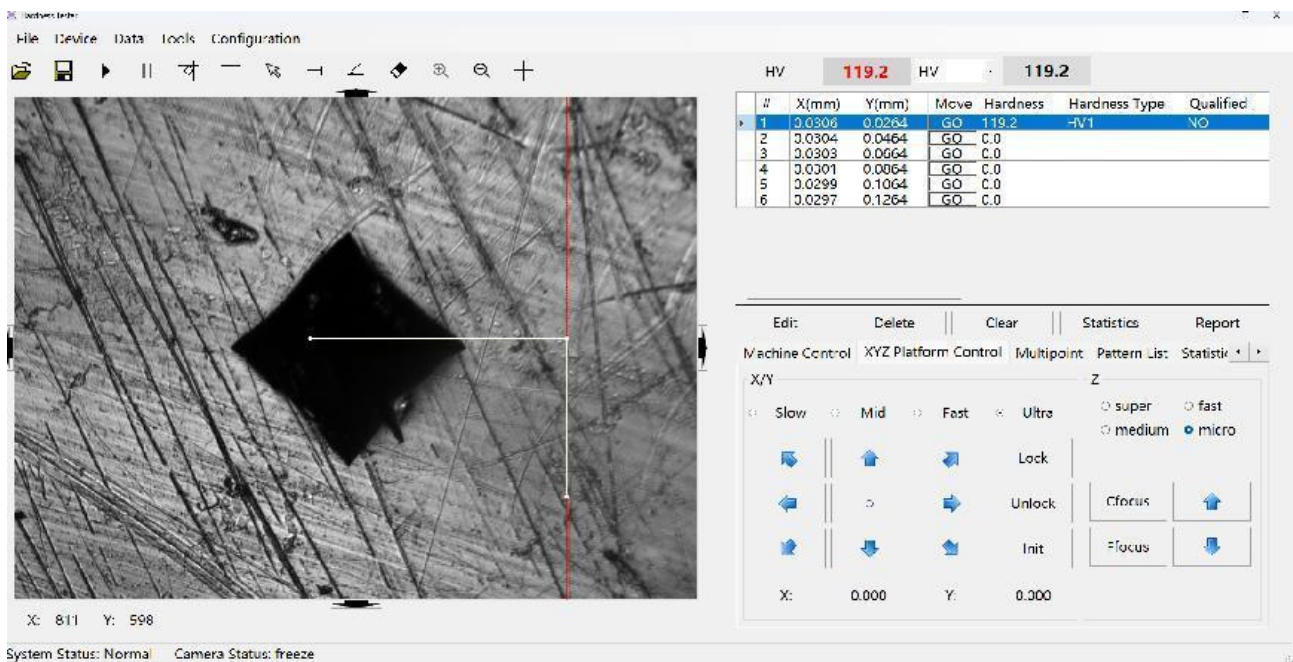

12.About The Software Hardness Type Conversion Function

The software can convert the currently measured HV Vickers hardness value into HRC , HBW, HK and other hardness values.

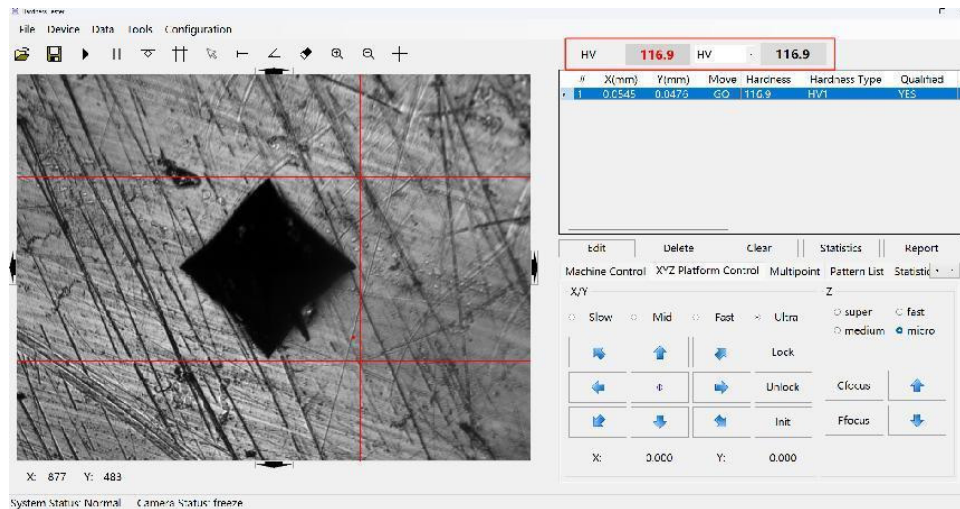

13.About The "Auto Focus" Feature

- 1.Before automatic focusing, you need to set reasonable Z-axis up and down travel values in "Settings-Auto Focus Settings" (generally, the software has been set up by the debugging personnel before leaving the factory, and the user only needs to use it).
- 2.Before automatic focusing, make sure that the Z-axis screw is within the focusing range (the object can be seen blurry).
- 3.Click the " Auto Focus " button, the Z axis will be locked and the software will start to focus automatically. After the auto focus is completed, the indentation and the Z axis will be stationary.

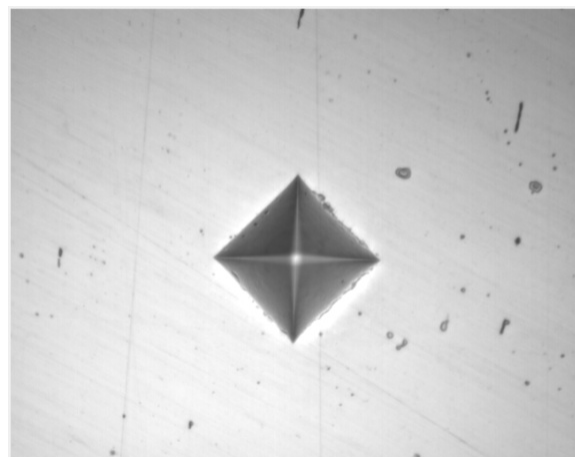
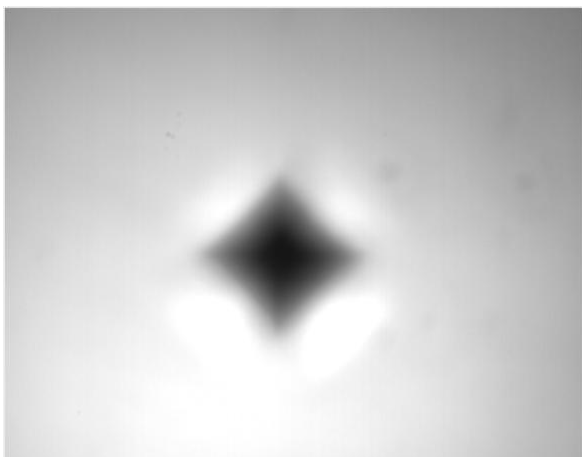

14.About The Electric And Manual Movement Of The Xy Two-Dimensional Translation Stage And The Z Lifting Axis

- 1.Before jogging or manual moving, make sure the platform is not moving.
- 2.the eight blue direction buttons such as up, down, left, and right in the X /Y axis control area in the main interface , and the XY two-dimensional translation stage will move in the corresponding direction.
- 3.Click the two blue up and down buttons in the Z-axis control area in the main interface to make the lifting axis rise and fall.
- 4.The “low speed, medium speed, high speed, and ultra-high speed” on the interface are used to adjust the moving speed during electric driving.

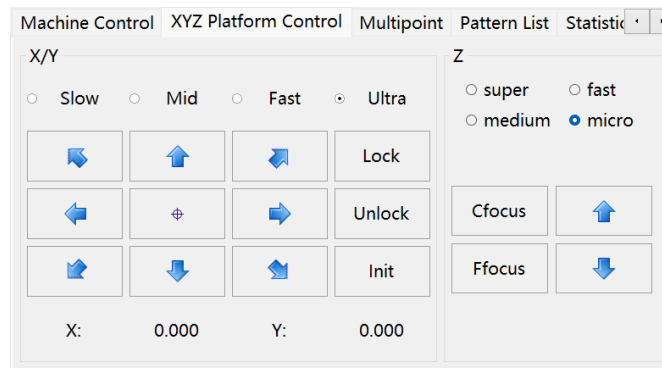

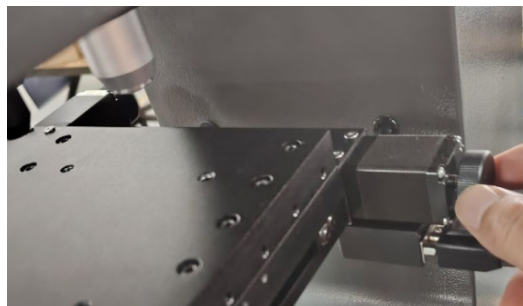

- 5.By clicking a button, the XY stage can be controlled manually.

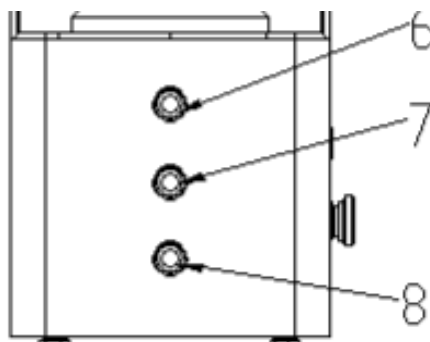

- 6.The lifting shaft can be manually raised or lowered by buttons 6 and 7.



- 7.Click   the button, and the XY platform and the lifting axis motor will be enabled. At this time, the hand cannot be turned (if forced to turn, the corresponding mechanism may be damaged).

15.About The Software Data Logging Function

1.All data during the software measurement process are recorded in the table on the upper right corner of the software.

#	X(mm)	Y(mm)	Move	Hardness	Hardness Type	Qualified
1	0.0545	0.0476	GO	116.9	HV1	YES

2.Select a record, click the "**EDIT**" button, edit the record in the pop-up edit box, and click the "OK" button in the editing interface after editing.

Edit Record

Index	<input type="text" value="1"/>	Hardness Type	<input type="text" value="HV1"/>
Measure Time	<input type="text" value="10:07:53"/>	Hardness	<input type="text" value="116.9"/>
D1(um)	<input type="text" value="125.602"/>	Qualified	<input type="text" value="YES"/>
D2(um)	<input type="text" value="126.306"/>	Convert Type	<input type="text" value="HV"/>
Davg(um)	<input type="text" value="125.954"/>	Convert Value	<input type="text" value="116.9"/>
Depth(mm)	<input type="text" value="0"/>		

3.You can select one or more records and click the "**DELETE**" button to delete the data in the record table; click the "**CLEAR**" button to delete all records in the record table.

4.Click the "**STATISTIC**" button to count the maximum, minimum, average, and standard deviation of the data in the table.

Statistics Info			
Number	1	Variance	0.00
Min	116.90	StdDev	0.00
Max	116.90	CP	INF
Average	116.90	CPK	INF

15.About The Software Data Logging Function

5.Click the "**REPORT**" button, select the report template, click "Export", and the marked data will be exported to the corresponding document.

Export Report

CSV Report

Excel Report

Word With Data Only

Word With Image

Word With Deep Hardness

Word With Image And Deep Hardness

Report

Sample Name	Sample Name	Sample Sn	Sample Sn
Max Value	800.0	Min Value	200.0
Inspection Company	Inspection Company	Inspection Data	2020/08/19

Staistical results

No	Max	Min	Ave	Var	Cp	Cpk
2	745.00	714.61	729.80	15.20	6.58	1.54

Detailed data

#	D1(um)	D2(um)	DAvg(um)	Hardness type	Hardness value	Convett type	Convett value	Time	Qualified
1	49.78	50.00	49.89	HV	745.00	HRC	61.96	2020-08-20 14:21:55	YES
2	50.62	51.27	50.94	HV	714.61	HRC	60.77	2020-08-20 14:33:31	YES

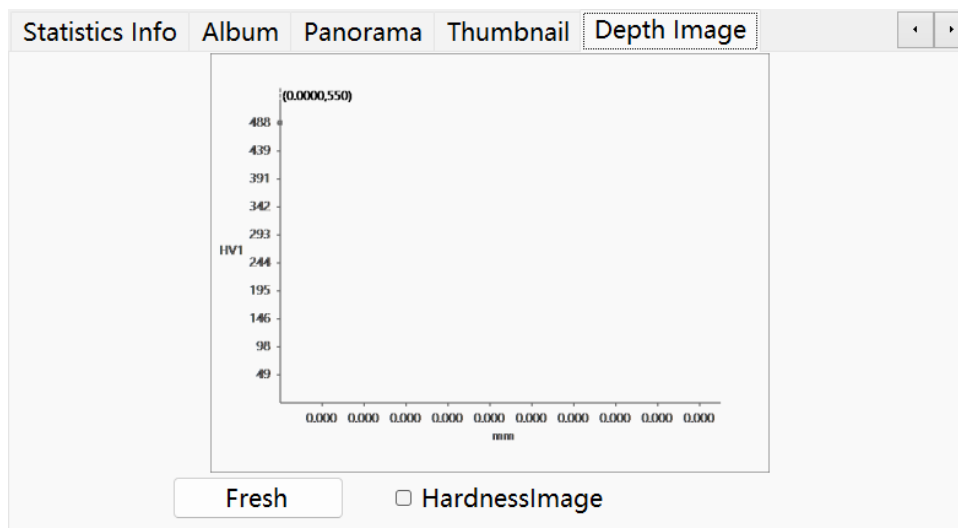
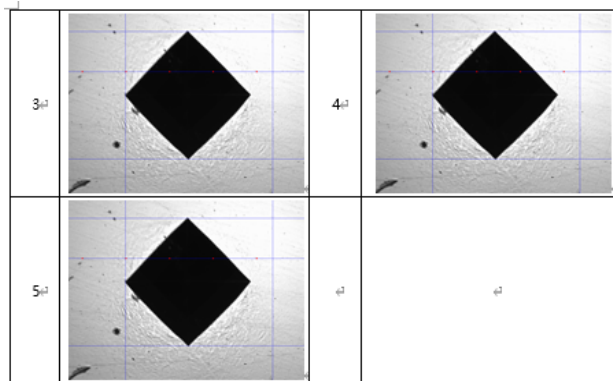



16.About The "Geometry Measurement" Feature

1.Before performing geometric measurement, you need to perform length calibration and select length calibration.

2.Clear icon: Click the button in the interface  to clear the image measurement data currently displayed in the main interface.

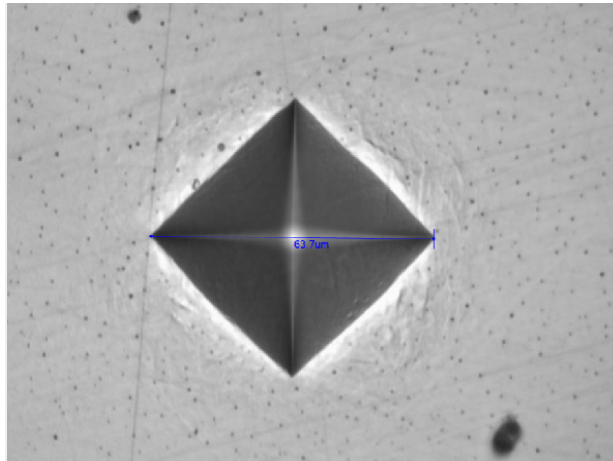
3.Length measurement: Click the button in the interface , and click the two points on the interface where you want to measure the distance. The measurement results are at the bottom of the interface.



4.Angle measurement: Click on the interface and  click 3 times on the interface. The acute angle formed is the measured angle, and the angle value is displayed at the bottom of the interface.

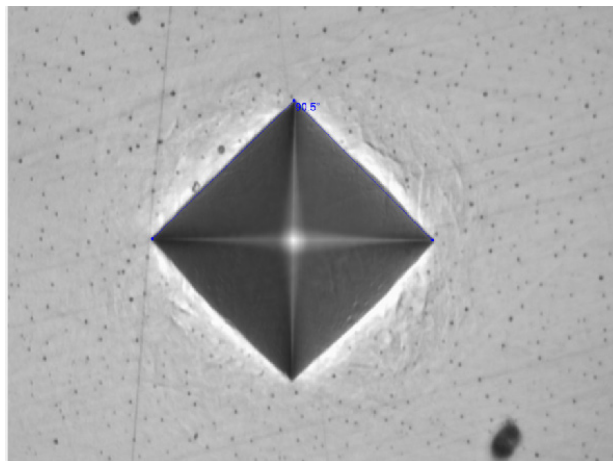

17.About The "Multi-Point Measurement" Function

- 1.This feature is the most important feature in semi-automatic and fully automatic software.
- 2.If multi-point measurement is required, "center positioning" must be performed first after the software is restarted.
- 3."**MULTIPOINT**" button in the main interface to bring up the mode setting interface.

Reference	X	Y
	-0.02628	0.01796
	0.05222	0.04512
	-0.02628	0.01796

Interval: 0.02 Offset: 0

First Offset: 0 Angle: -90

Number: 6

Buttons: Save, Load, Start, Generate, Multiset (checkbox), Indenting (radio), One Pass (radio), Two Pass (radio, selected), FocusAll (radio), Reset

- 4.Select the corresponding measurement mode in "Mode". The following takes "Vertical Mode" as an example.
- 5.Click the button to the right of "Starting Point"  , and then click the reference point where you want to mark in the image display area (a small red dot will appear in the image display area after clicking).

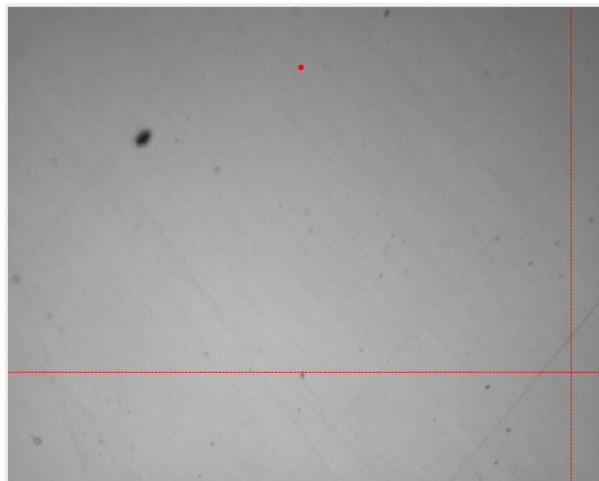

17.About The "Multi-Point Measurement" Function

6. Enter the vertical interval of the points in the "Interval" parameter, enter the offset distance between the fixed point and the baseline when the "zigzag" method is used in the "Offset", and enter the vertical distance between the first point position when actually dotting and the previously selected "Starting Point Position" in the "First Point Distance". Enter the number of points to be dotted in the "Number of Points". Finally, click "Generate Curve".

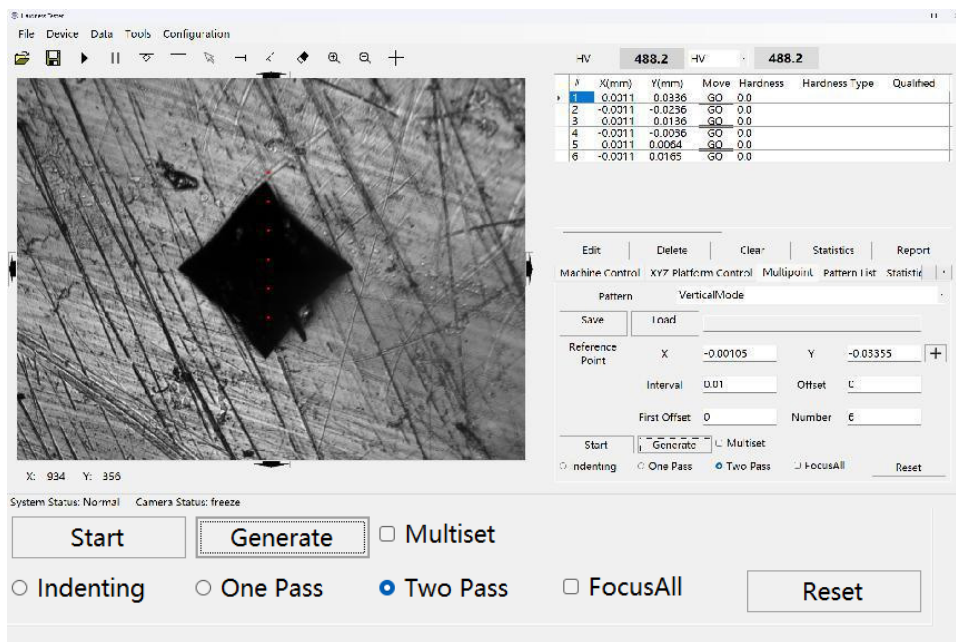

The above mode means that only multiple points of suppression are carried out, and after the suppression is completed, it will stop at the last point.

The user needs to click "GO" in the data entry in the data log to move to different points for manual focus and then measure.

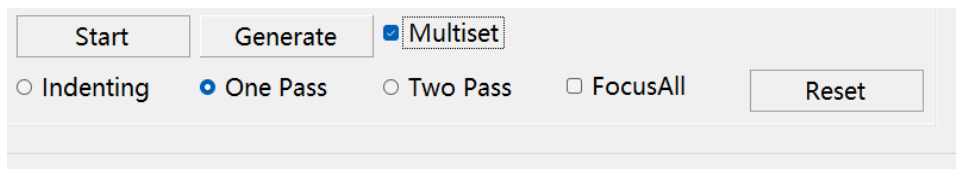

The above mode means that when pressing multiple points, one point will be measured after each point is pressed until all points are completed. This mode requires the sample to be polished flat and smooth, and to ensure that the focus is on a clear plane before pressing.

17.About The "Multi-Point Measurement" Function

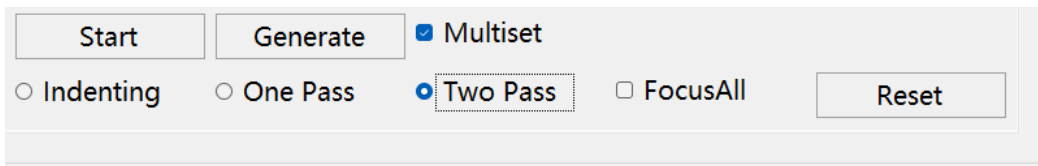

The above mode means that after the multi-point indentation is completed, it will automatically move to the first point and then move to each indentation one by one to automatically measure the indentation. This mode requires the sample to be polished and smooth, and to ensure that the focus is on a clear plane before indentation.

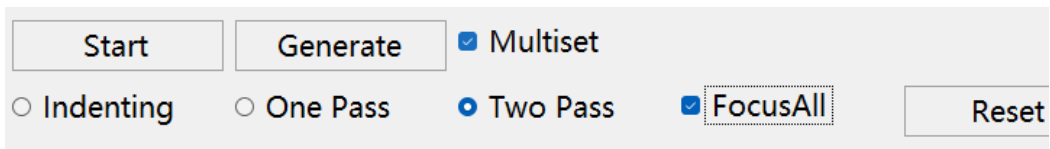

The above mode means that after the multi-point indentation is completed, it will automatically move to the first point and then move to each indentation one by one to automatically focus on the indentation and then automatically measure it. This mode requires the sample to be polished flat and smooth.

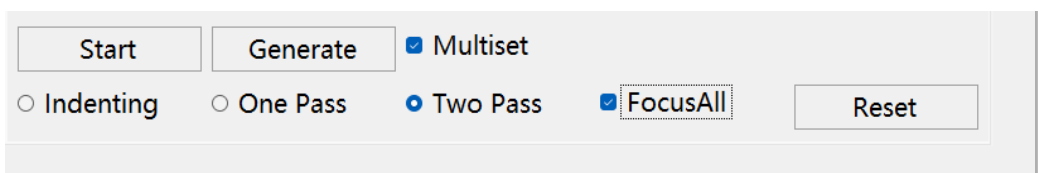

The above mode means that when pressing multiple points, each point will be automatically focused and measured until all points are completed. This mode requires the sample to be polished flat and smooth.

8.Click on the mode setting interface  , and the device starts multi-point pressing and measurement. (Do not perform any other operations during the multi-point pressing process).

9.Other multipoint modes are described below.

17.About The "Multi-Point Measurement" Function

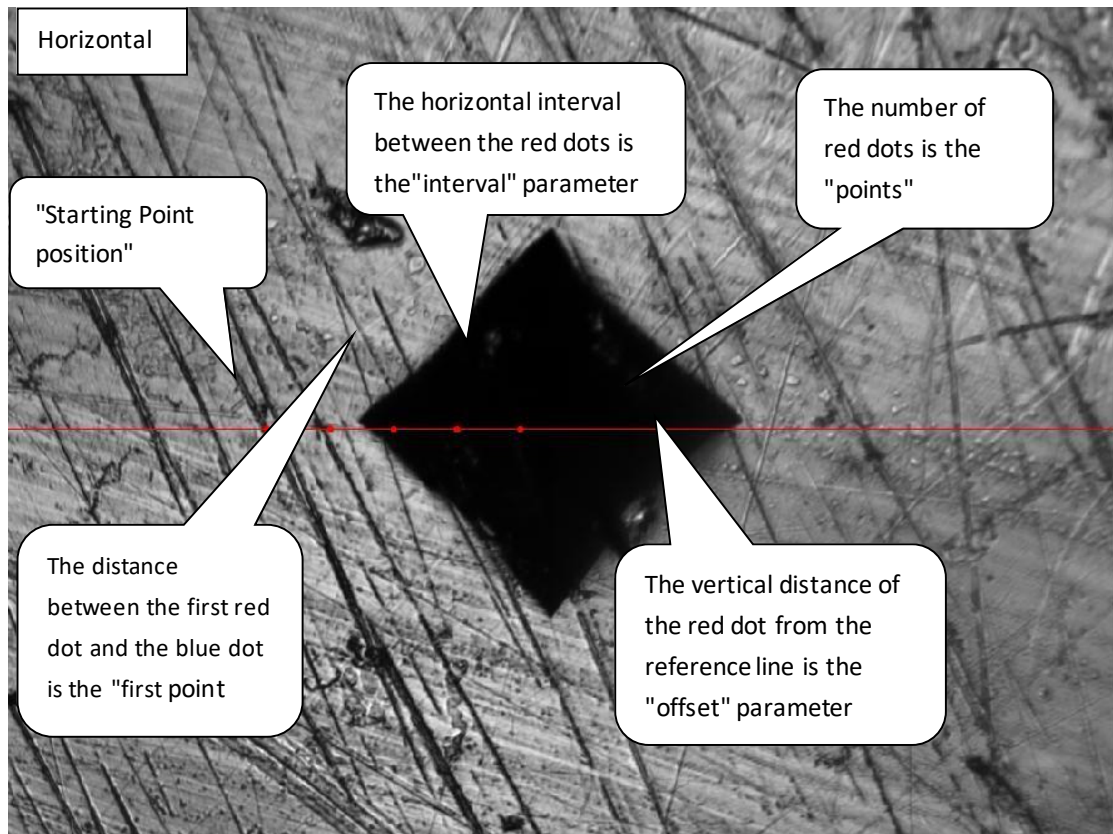

Machine Control	XYZ Platform Control	Multipoint	Pattern List	Statistic
Pattern		HorizontalMode		
Save	Load			
Reference Point	X	-0.04678	Y	0.00114
	Interval	0.01	Offset	0
	First Offset	0	Number	5
Start	Generate	<input checked="" type="checkbox"/> Multiset		
<input type="radio"/> Indenting	<input type="radio"/> One Pass	<input checked="" type="radio"/> Two Pass	<input checked="" type="checkbox"/> FocusAll	Reset

17.About The "Multi-Point Measurement" Function

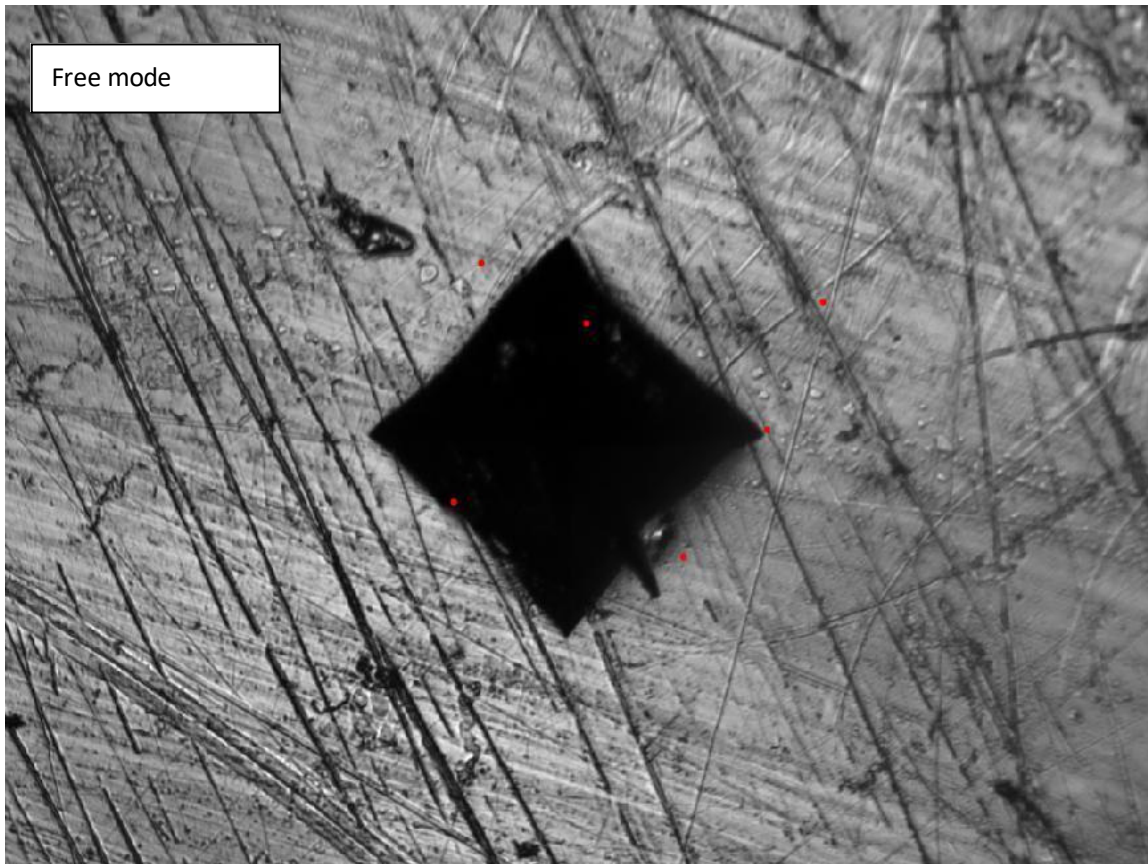

Machine Control | XYZ Platform Control | Multipoint | Pattern List | Statistics

Pattern: FreeMode

+ [] [] Add Point

Save Program | Load Program | Delete | Clear

No.	X(mm)	Y(mm)
1	-0.01507	-0.02655
2	0.02874	-0.00096
3	-0.01927	0.01008
4	0.00105	-0.01726
5	0.03732	-0.02059

Start | Generate | Multiset

Indenting | One Pass | Two Pass | FocusAll | Reset

After clicking the small plus sign, click the location where you want to mark in the image display area.

17. About The "Multi-Point Measurement" Function

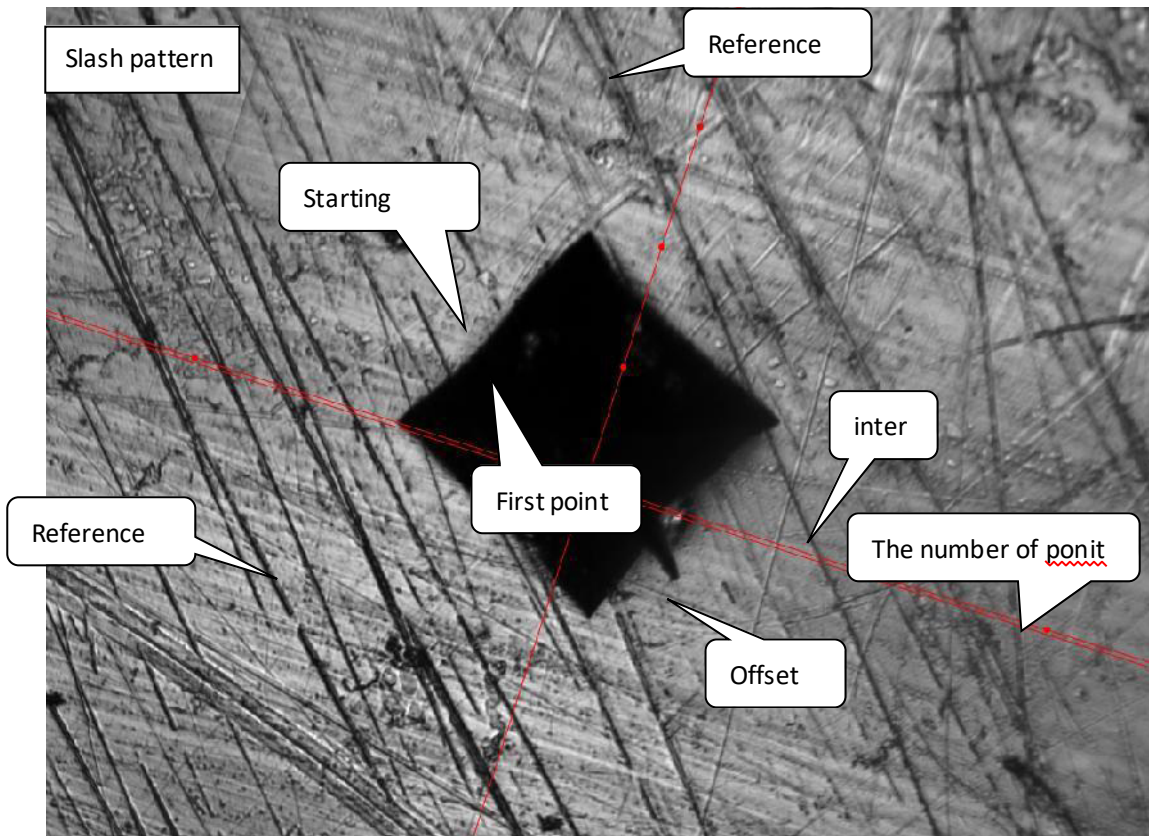

Machine Control XYZ Platform Control **Multipoint** Pattern List Statistic

Pattern **Case Depth Mode**

Reference	X	-0.06448	Y	-0.01043	+
	X	0.07061	Y	0.03268	
Reference	X	-0.00263	Y	0.01008	+
Interval		0.02	Offset		0
Save	First Offset	0	Angle		-90
Load					
Start	Generate	<input checked="" type="checkbox"/> Multiset			
<input type="radio"/> Indenting		<input type="radio"/> One Pass		<input checked="" type="radio"/> Two Pass	
				<input checked="" type="checkbox"/> FocusAll	
Reset					

17. About The "Multi-Point Measurement" Function

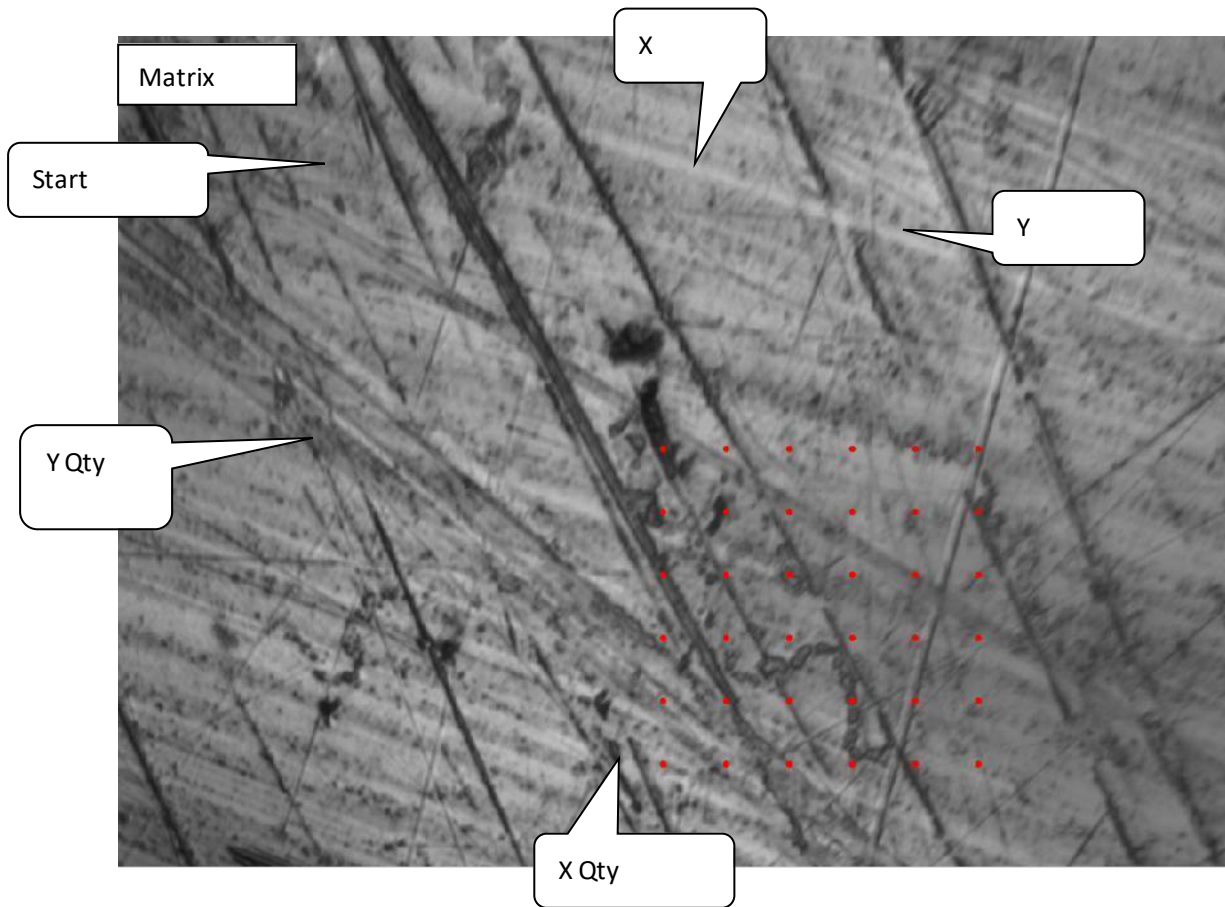

Machine Control XYZ Platform Control **Multipoint** Pattern List Statistics

Pattern MatrixMode

Save Load

Reference Point X Y

Interval X Y

Number Rows Columns

 Multiset

Indenting One Pass Two Pass FocusAll

17.About The "Multi-Point Measurement" Function

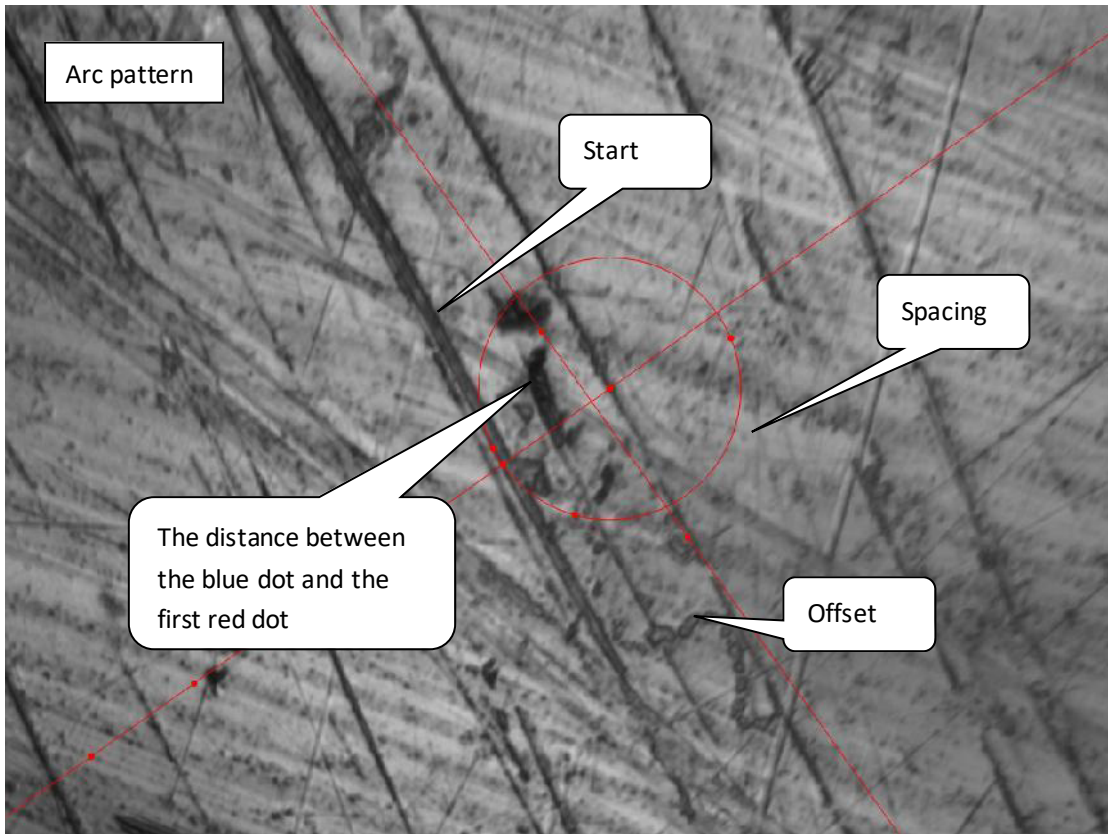

Machine Control XYZ Platform Control Multipoint Pattern List Statistic

Pattern CircleMode

Reference	X	-0.00298	Y	-0.01428	+	Interval	0.02
	X	0.02015	Y	0.01831		Offset	0
Reference	X	0.02698	Y	-0.01323	+	First	0
Reference	X	-0.01069	Y	0.00429	+	Angle	90
Reference	X	0.00228	Y	0.01481	+	Number	6
Circle Center	X	0.00779	Y	-0.00524		Save	Load

Start **Generate** Multiset

Indenting One Pass Two Pass FocusAll Reset

18.About The Method And Calculation Of Carburizing Layer

- 1.To drill the carburized layer, you need to use the "oblique line mode" in multi-point measurement.
- 2.Find the edge of the test sample under the objective lens.

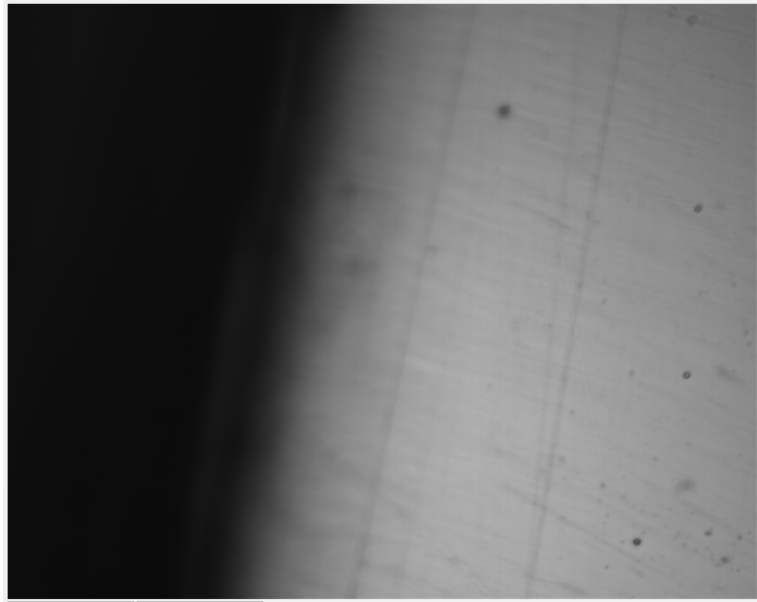

- 3.The oblique line modes "Location point 1" and "Location point 2" determine the reference line of the sample edge.

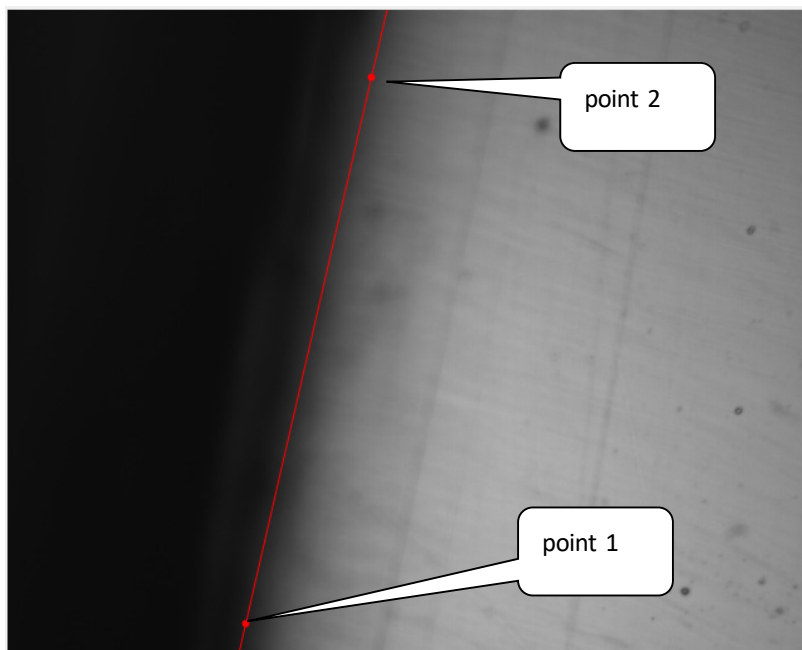

- 4.Enter the corresponding slash mode parameters according to the sample parameters.

18.About The Method And Calculation Of Carburizing Layer

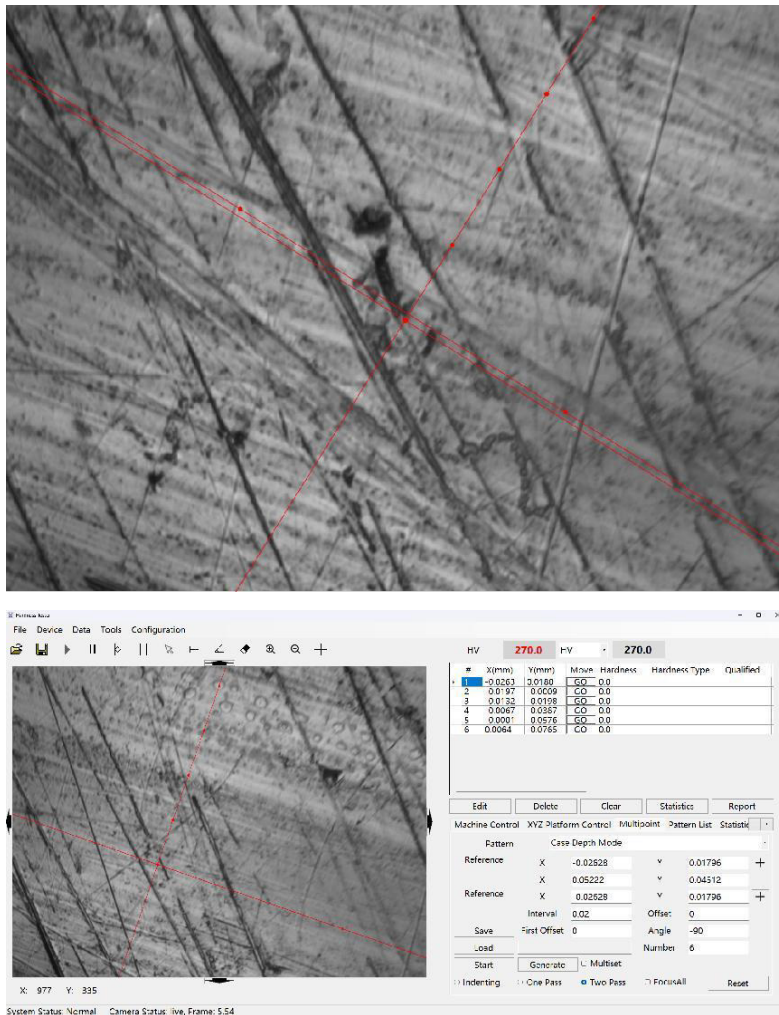

5.After the pressing and measurement are completed, enter the carburized layer hardness value of the sample in Settings-General Settings

6.After the pressure measurement is completed, click the "Report" button to export the report, and the carburized layer of the current sample will be displayed in the report.

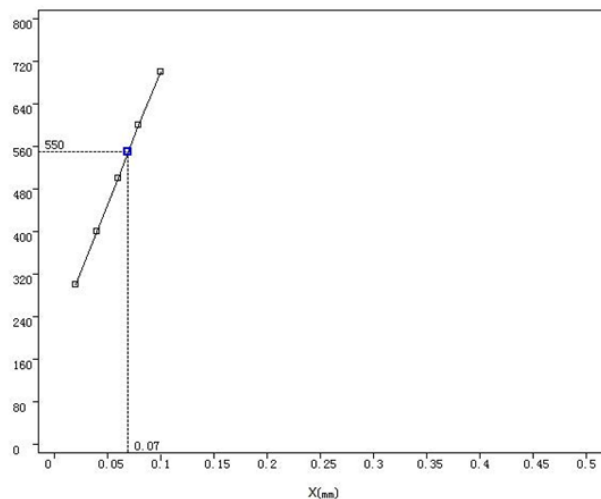

19. Attachments (Packing List)

(This list is for reference only. The type or quantity of attachments shall be subject to the contract)

1. Main unit (including one macro-Vickers indenter, one 10[×] and one one 40[×] objective lens)

2. Panoramic camera

3. Computer

4. Accessory box

Serial Number	Name (Specification)	Quantity
1	Automatic XY stage	1
2	Adjusting screw	4
3	Vickers Hardness Test Blocks	2 pieces
4	Spare fuse (2A)	2
5	Touch pen	1
6	Level	1
7	Dust cover	1
8	Power cord	1 pc
9	Hexagon wrench (2.5 mm)	1
10	Product Certificate	1 serving
11	Product Instructions	1 serving
12	USB data cable	1 pc
13	Flat clamping table	1
14	Sheet clamping table	1
15	Filament clamping table	1
16	Large, medium, and V-shaped test benches	Each 1

Mikrosize Distributors Worldwide

Coventry,UK /Warsaw,Poland/Burago di Molgora, Italy/Langgöns,Germany/
Madrid, Spain/Istanbul,Turkey/Minsk,Belarus/Moscow , Russia /Sao Paulo, Brazil/
Mexico City ,Mexico/Penang, Malaysia/Bangkok Thailand etc.....



Anhui Mikrosize Precision Instrument Co.,Ltd

Factory Producing Add: N013 Shuiku Road Shatou, Changan Town, Dongguan, China.

International Trading Office: A-4035 RuiFeng Business Expo , Wuhu City, China.

Web: www.mikrosize.com Email: mikrosize@mikrosize.com

